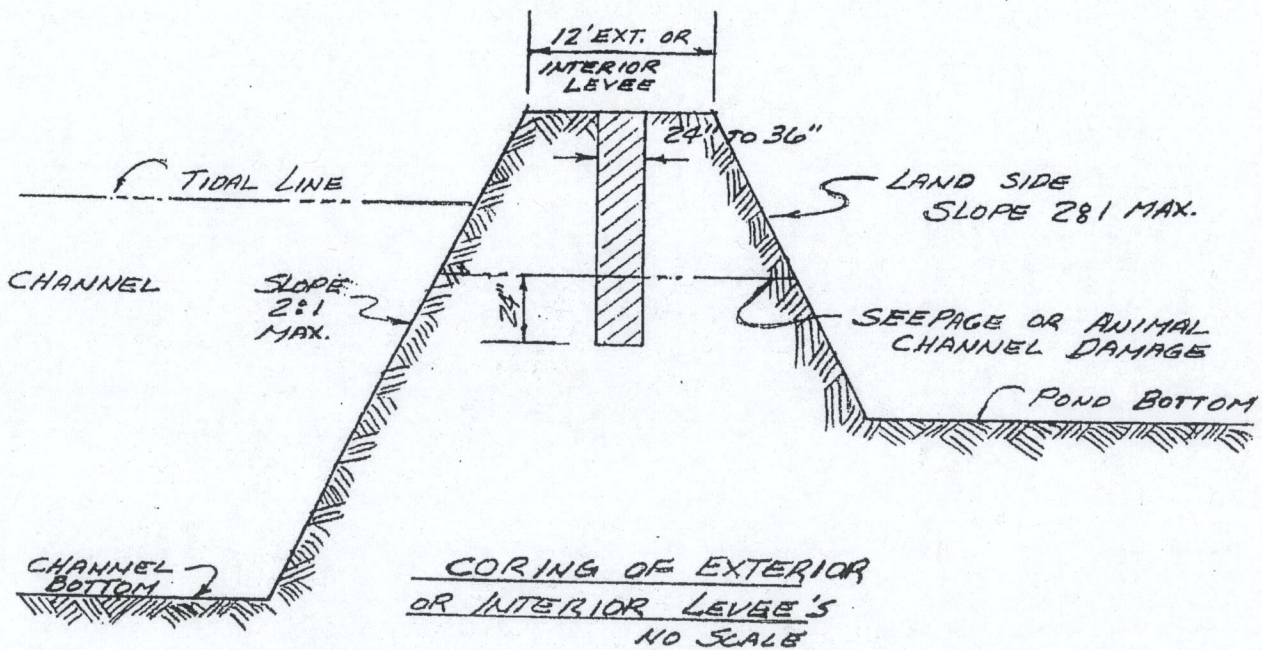
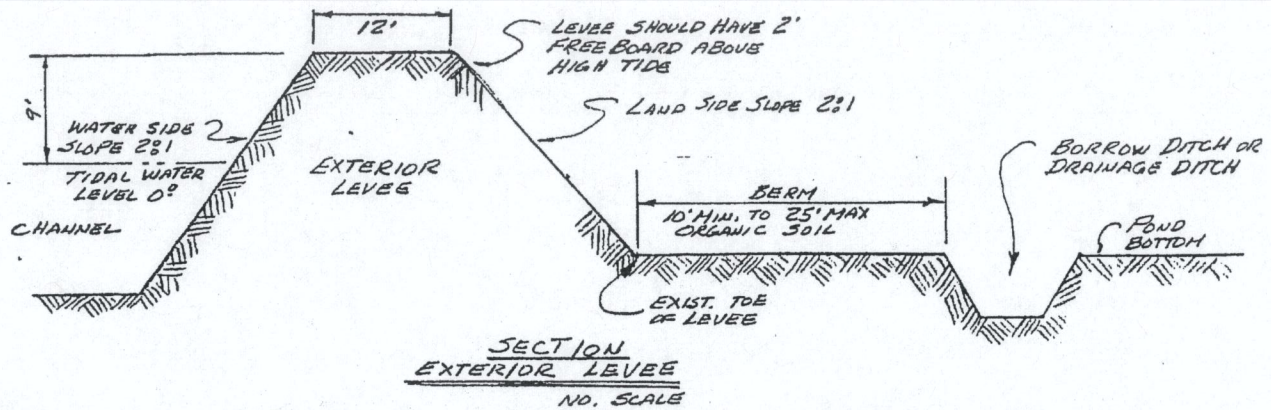
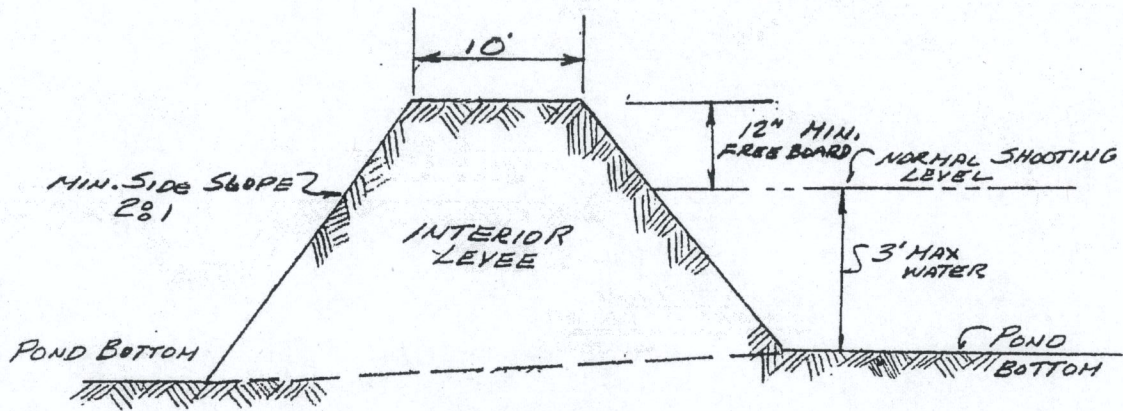

Figure 1
Project Location



<p>Purpose: Conduct annual wetland maintenance activities to protect and enhance Suisun Marsh managed wetlands. Datum: MLLW Property Owners: 1. Suisun Resource Conservation District (SRCD) and private landowners 2. California Department of Fish and Wildlife (DFW) 3. California Department of Water Resources (DWR)</p>	<p>TYPICAL CROSS SECTIONS No Scale Location: Suisun Marsh - Near Fairfield CA. At: Individually Owned State and Private Properties County: Solano State: CA</p>	<p>Application By: 1) SRCD: 2544 Grizzly Island Rd. Suisun CA. 94585 2) DFW: 2109 Arch-Airport Rd. Suite 100, Stockton CA. 95206 3) DWR: 3500 Industrial Blvd. West Sacramento, CA. 95691 4) U.S. Bureau of Reclamation 801 I St. Suite 140, Sacramento CA. 95814 Sheet 2 of 7 Date: 6/26/13</p>
---	--	--



SECTION
INTERIOR LEVEE
NO SCALE

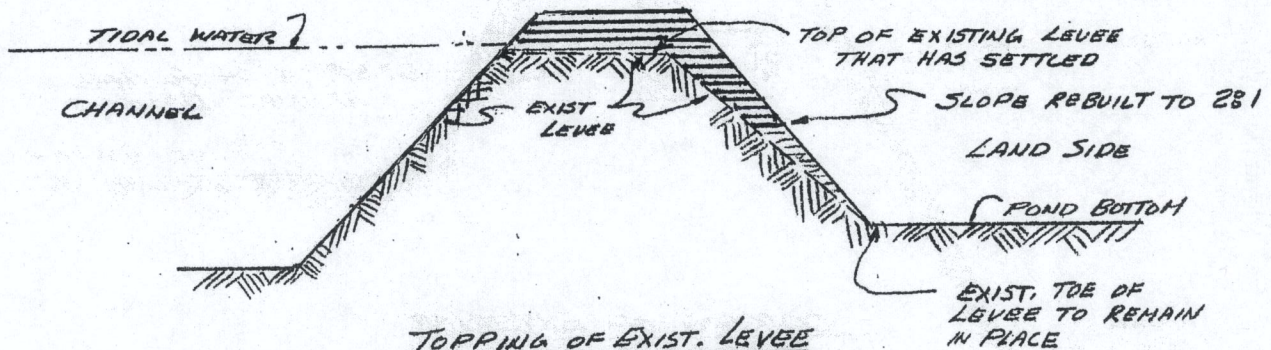

TOPPING OF EXIST. LEVEE
AND REPAIRING SIDE SLOPES
NO SCALE
WITH SETTLEMENT & EROSION

<p>Purpose: Conduct annual wetland maintenance activities to protect and enhance Suisun Marsh managed wetlands. Datum: MLLW Property Owners: 1. Suisun Resource Conservation District (SRCD) and private landowners 2. California Department of Fish and Wildlife (DFW) 3. California Department of Water Resources (DWR)</p>	<p>TYPICAL CROSS SECTIONS No Scale Location: Suisun Marsh - Near Fairfield CA. At: Individually Owned State and Private Properties County: Solano State: CA</p>	<p>Application By: 1) SRCD: 2544 Grizzly Island Rd. Suisun CA. 94585 2) DFW: 2109 Arch-Airport Rd. Suite 100, Stockton CA. 95206 3) DWR: 3500 Industrial Blvd. West Sacramento, CA. 95691 4) U.S. Bureau of Reclamation 801 I St. Suite 140, Sacramento CA. 95814 Sheet 3 of 7 Date: 6/26/13</p>
---	--	--

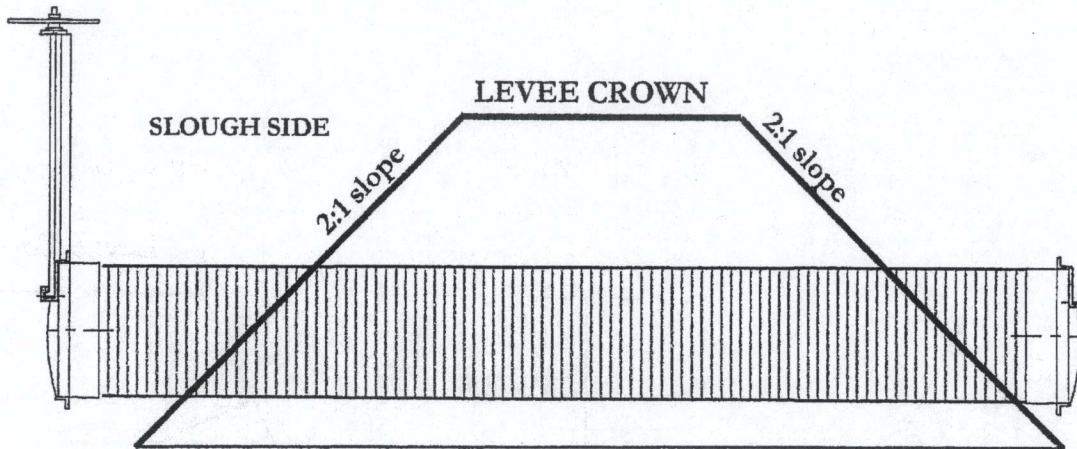

Typical Levee Section For a Flood Gate

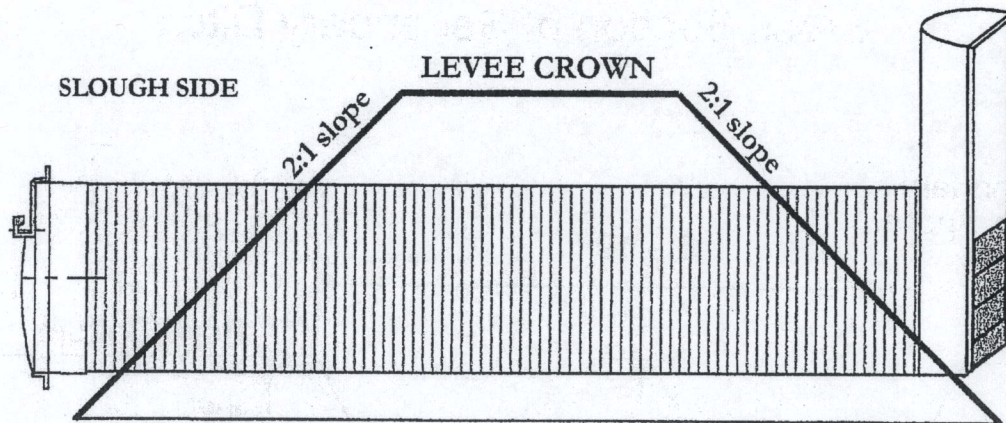

Typical Levee Section For a Drain Gate

<p>Purpose: Conduct annual wetland maintenance activities to protect and enhance Suisun Marsh managed wetlands. Datum: MLLW Property Owners: 1. Suisun Resource Conservation District (SRCD) and private landowners 2. California Department of Fish and Wildlife (DFW) 3. California Department of Water Resources (DWR)</p>	<p>TYPICAL CROSS SECTIONS No Scale Location: Suisun Marsh - Near Fairfield CA. At: Individually Owned State and Private Properties County: Solano State: CA</p>	<p>Application By: 1) SRCD: 2544 Grizzly Island Rd. Suisun CA. 94585 2) DFW: 2109 Arch-Airport Rd. Suite 100, Stockton CA. 95206 3) DWR: 3500 Industrial Blvd. West Sacramento, CA. 95691 4) U.S. Bureau of Reclamation 801 I St. Suite 140, Sacramento CA. 95814 Sheet 4 of 7 Date: 6/26/13</p>
--	--	---

Cross Section of Primary Ditch

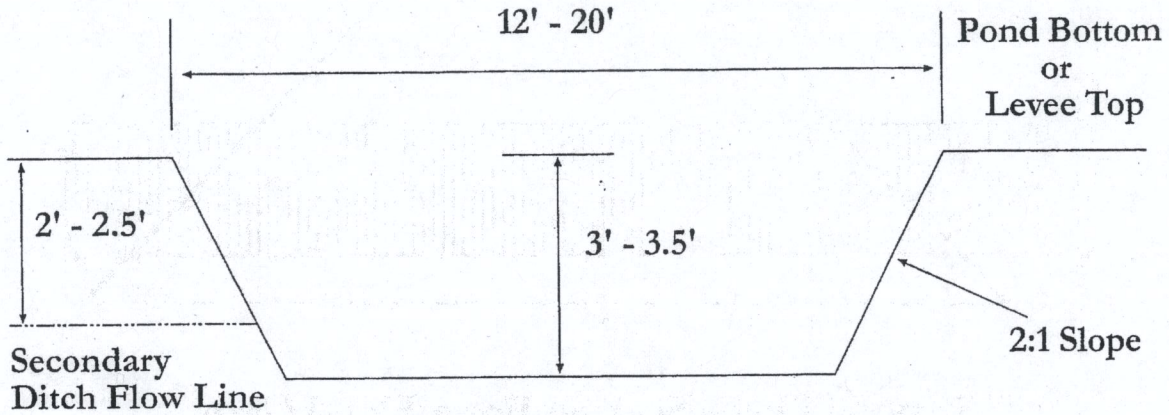

Cross Section of Secondary Ditch

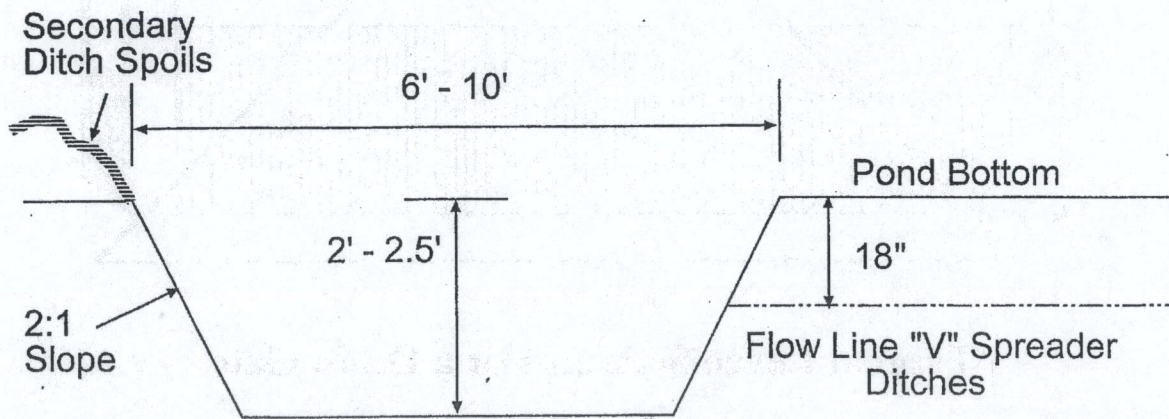

<p>Purpose: Conduct annual wetland maintenance activities to protect and enhance Suisun Marsh managed wetlands. Datum: MLLW Property Owners: 1. Suisun Resource Conservation District (SRCD) and private landowners 2. California Department of Fish and Wildlife (DFW) 3. California Department of Water Resources (DWR)</p>	<p>TYPICAL CROSS SECTIONS No Scale Location: Suisun Marsh - Near Fairfield CA. At: Individually Owned State and Private Properties County: Solano State: CA</p>	<p>Application By: 1) SRCD: 2544 Grizzly Island Rd. Suisun CA. 94585 2) DFW: 2109 Arch-Airport Rd. Suite 100, Stockton CA. 95206 3) DWR: 3500 Industrial Blvd. West Sacramento, CA. 95691 4) U.S. Bureau of Reclamation 801 I St. Suite 140, Sacramento CA. 95814 Sheet 5 of 7 Date: 6/26/13</p>
--	--	---

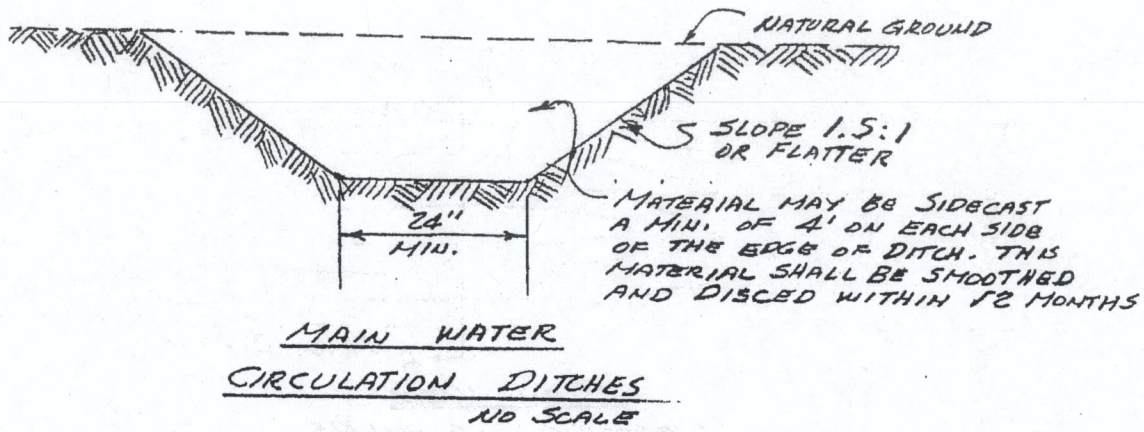

Cross Section "V" Spreader Ditch

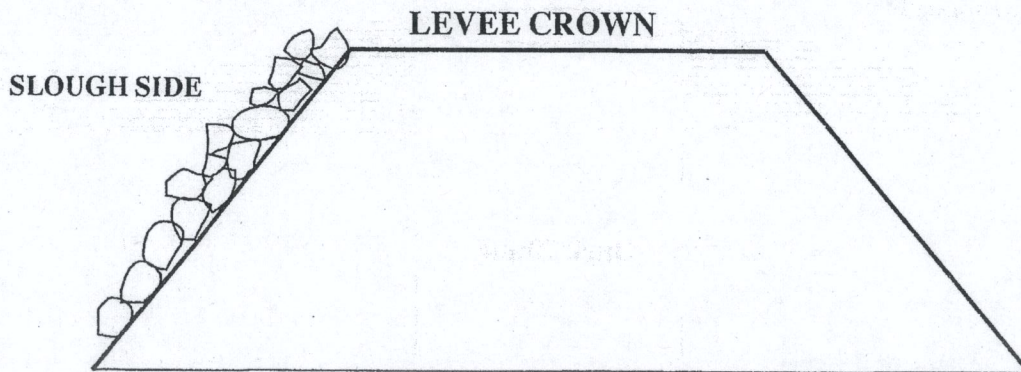
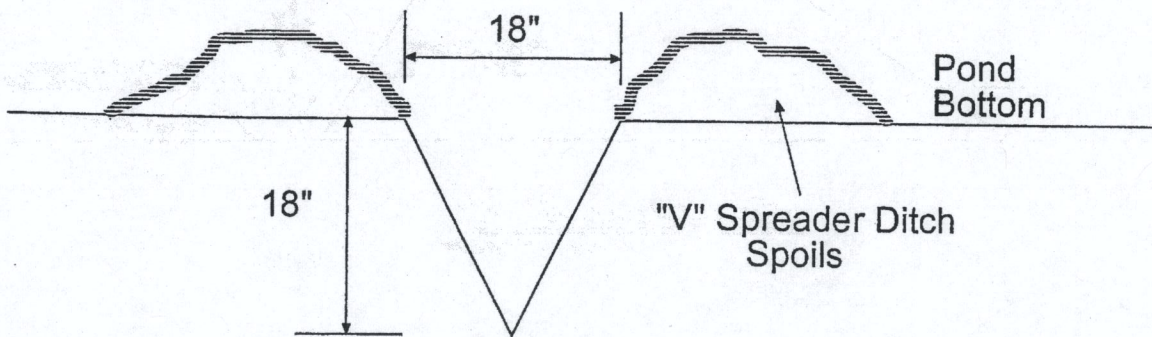

Typical Levee Section For the Replacement of Rip-Rap

<p>Purpose: Conduct annual wetland maintenance activities to protect and enhance Suisun Marsh managed wetlands. Datum: MLLW Property Owners: 1. Suisun Resource Conservation District (SRCD) and private landowners 2. California Department of Fish and Wildlife (DFW) 3. California Department of Water Resources (DWR)</p>	<p>TYPICAL CROSS SECTIONS No Scale Location: Suisun Marsh - Near Fairfield CA. At: Individually Owned State and Private Properties County: Solano State: CA</p>	<p>Application By: 1) SRCD: 2544 Grizzly Island Rd. Suisun CA. 94585 2) DFW: 2109 Arch-Airport Rd. Suite 100, Stockton CA. 95206 3) DWR: 3500 Industrial Blvd. West Sacramento, CA. 95691 4) U.S. Bureau of Reclamation 801 I St. Suite 140, Sacramento CA. 95814 Sheet 6 of 7 Date: 6/26/13</p>
--	--	---

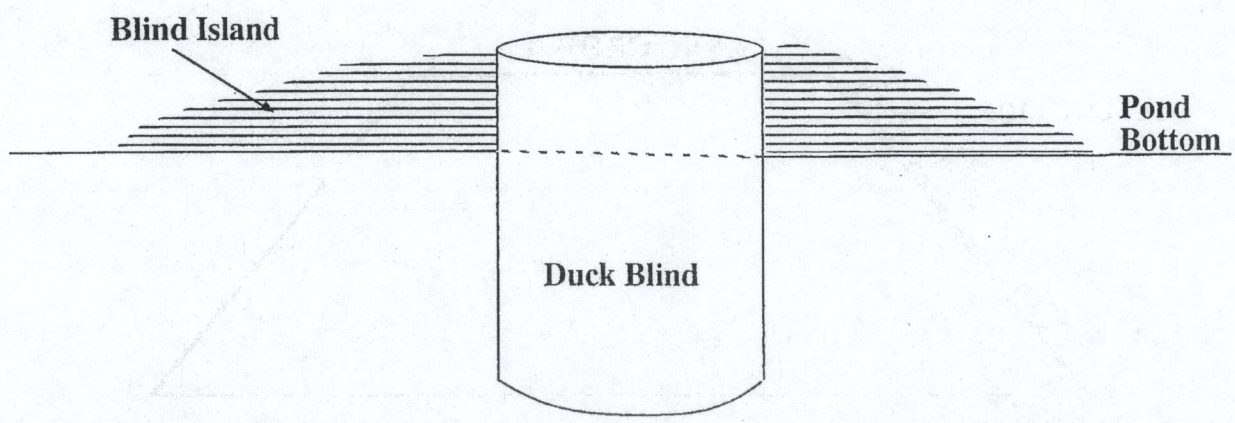
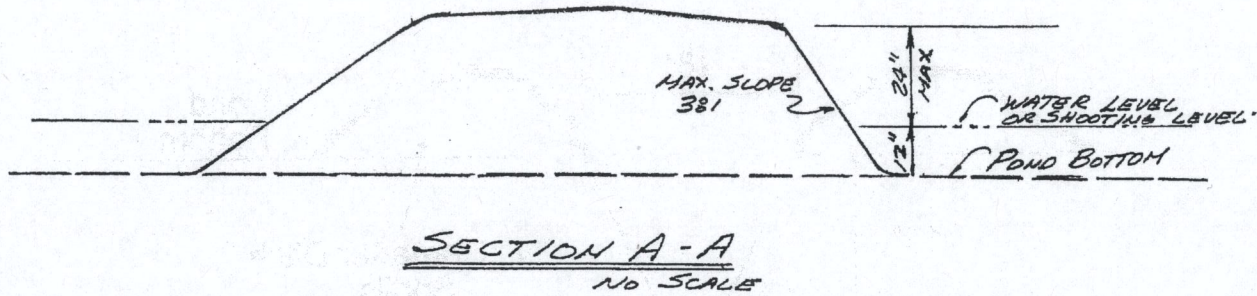
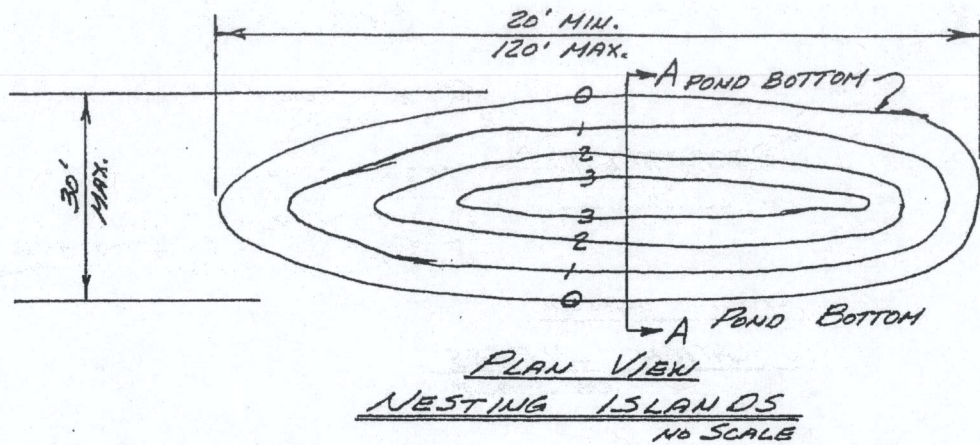

Typical Duck Blind and Blind Island Cross Section

<p>Purpose: Conduct annual wetland maintenance activities to protect and enhance Suisun Marsh managed wetlands. Datum: MLLW Property Owners: 1. Suisun Resource Conservation District (SRCD) and private landowners 2. California Department of Fish and Wildlife (DFW) 3. California Department of Water Resources (DWR)</p>	<p>PLAN VIEW & TYPICAL CROSS SECTIONS No Scale Location: Suisun Marsh - Near Fairfield CA. At: Individually Owned State and Private Properties County: Solano State: CA</p>	<p>Application By: 1) SRCD: 2544 Grizzly Island Rd. Suisun CA. 94585 2) DFW: 2109 Arch-Airport Rd. Suite 100, Stockton CA. 95206 3) DWR: 3500 Industrial Blvd. West Sacramento, CA. 95691 4) U.S. Bureau of Reclamation 801 I St. Suite 140, Sacramento CA. 95814 Sheet 7 of 7 Date: 6/26/13</p>
---	--	--

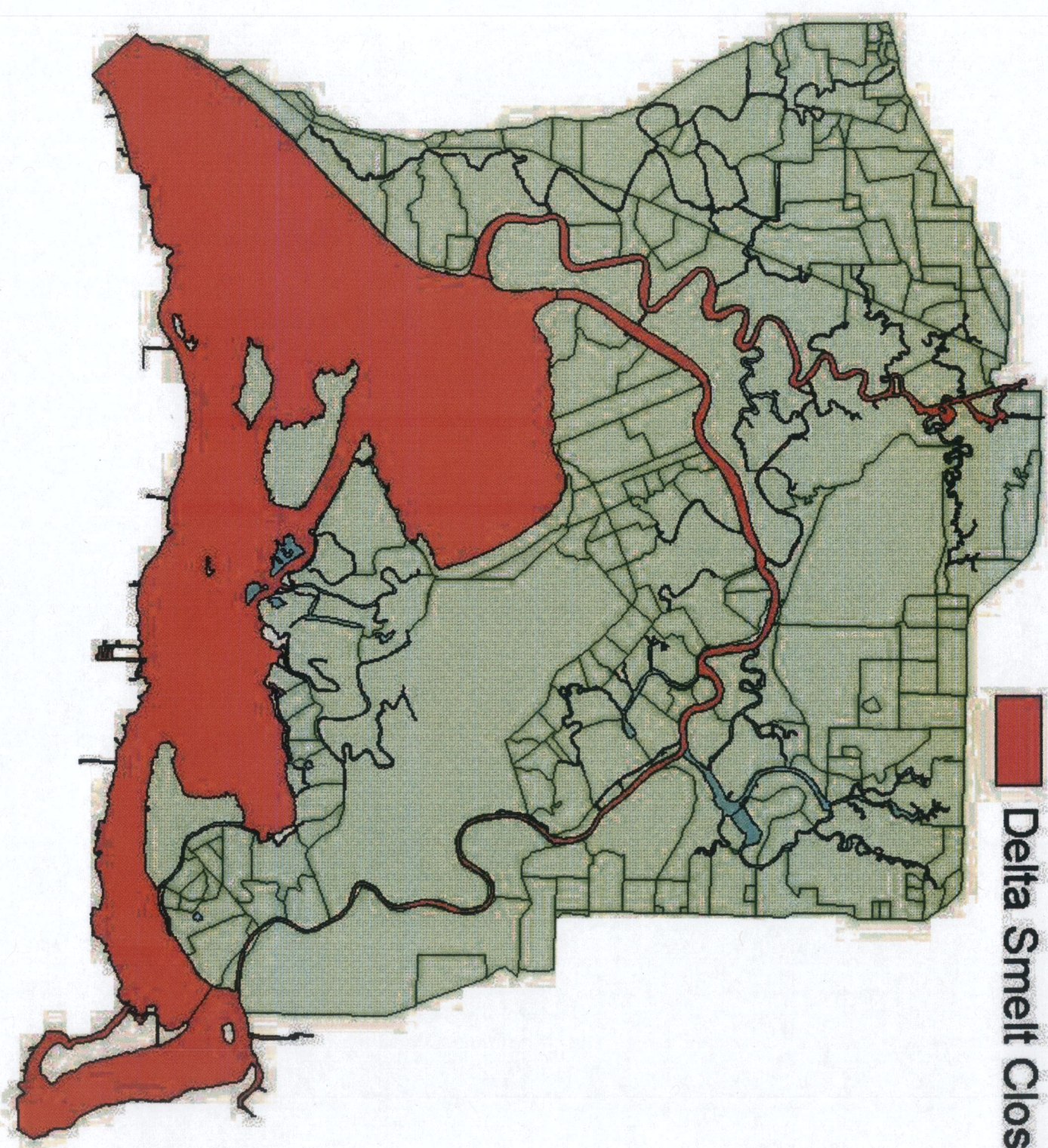

 Delta Smelt Closure Areas

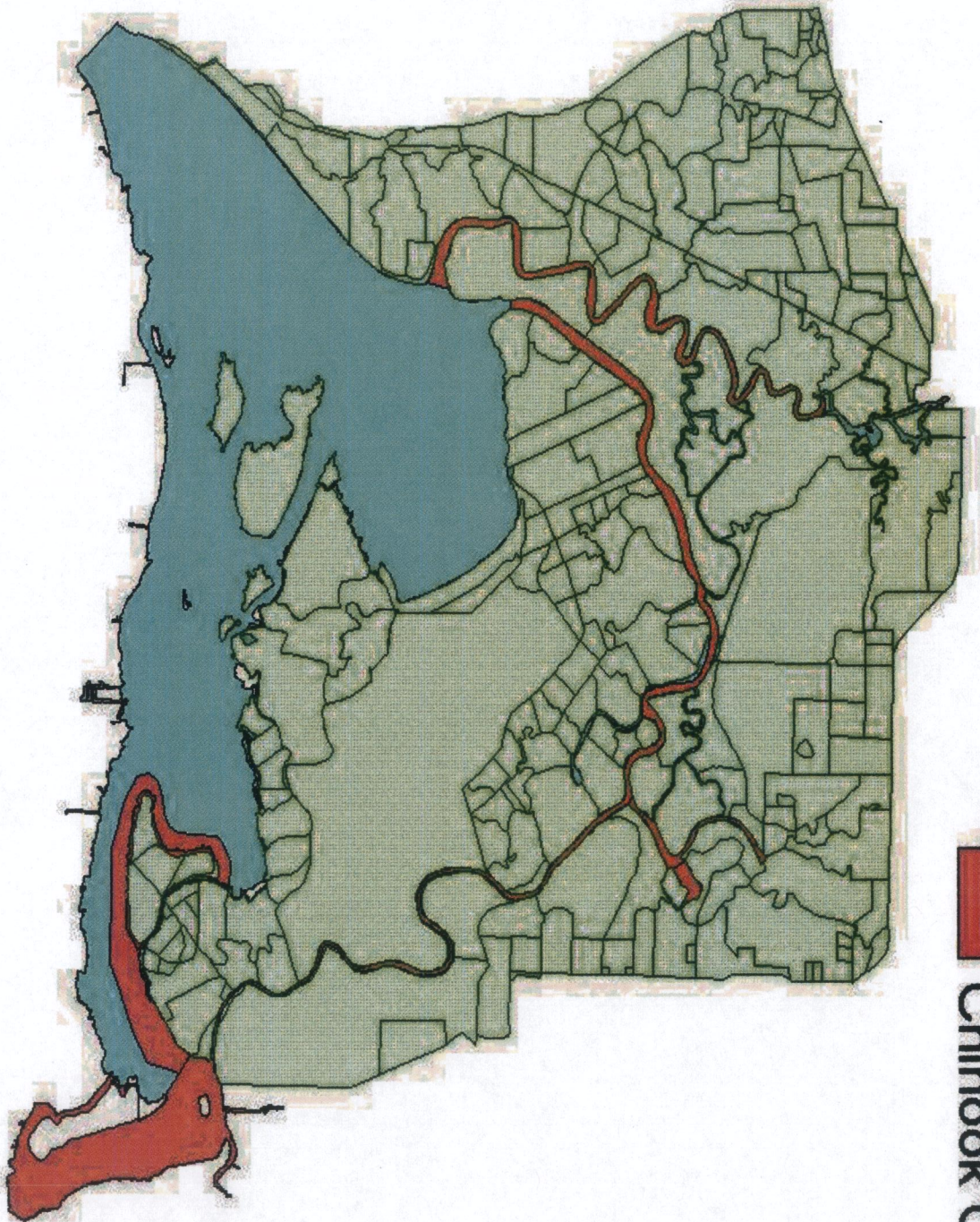

Chinook Closure Areas



Figure 2
California Clapper Rail Habitat in Suisun Marsh